

2007 Nissan Titan SE-Fig. 34: Exterior Lamps & Trailer Connector Circuit (2 of 2)

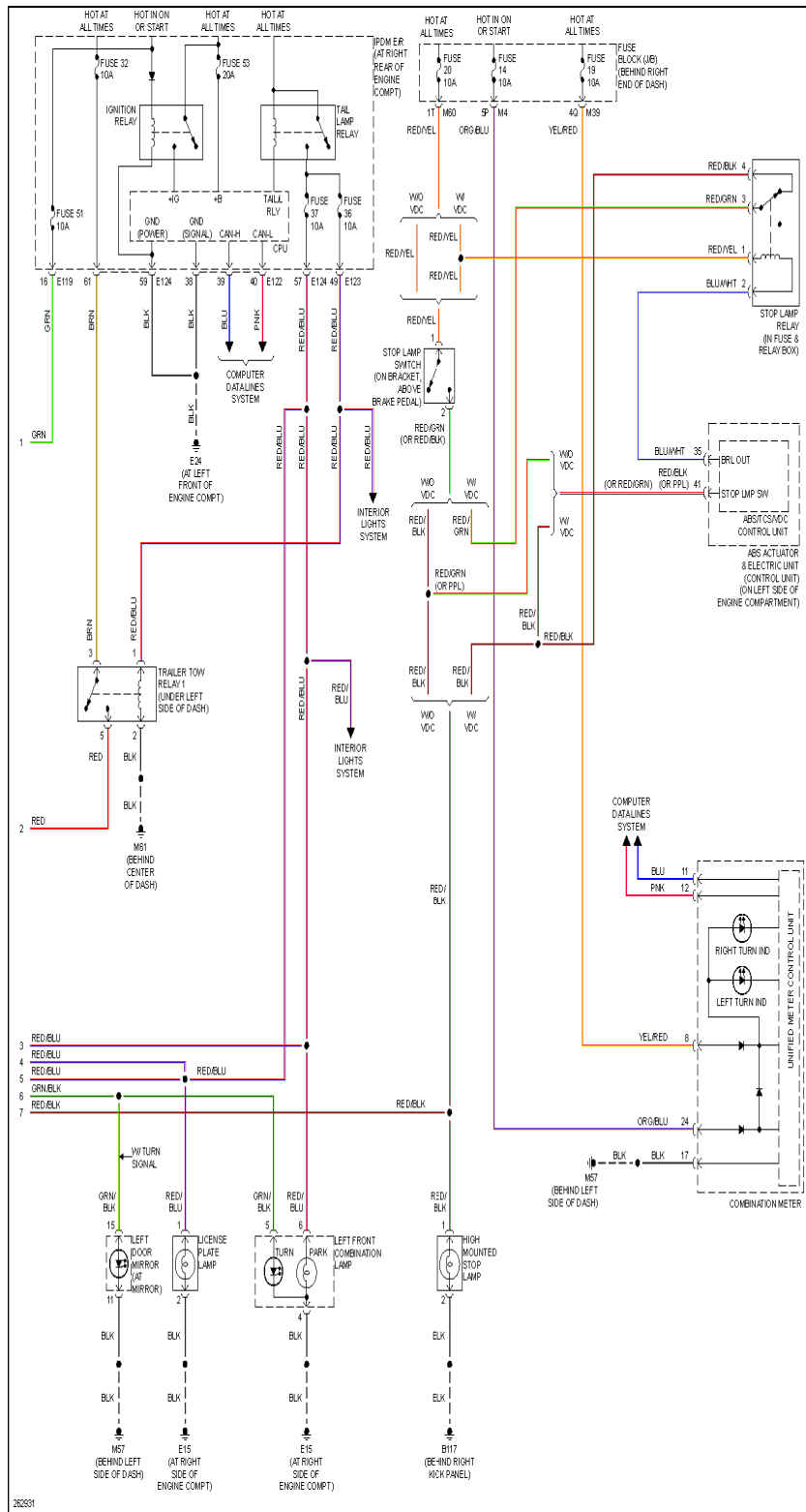

© 2008 Mitchell Repair Information Co., LLC.